

S32

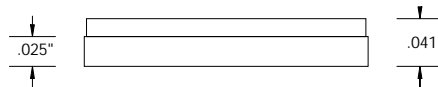
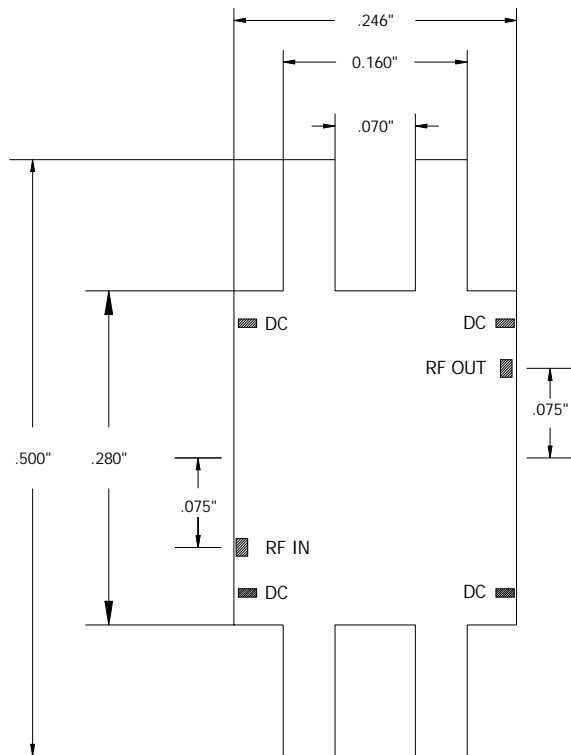

1. ALL DIMENSIONS ARE IN INCHS.
2. TOLERANCE:
 .XXX = $\pm .005$
 .XX = $\pm .01$